



**MODÈLES
DE PORTES
DOOR MODELS**

POLYESTER ET MÉLAMINE
POLYESTER AND MELAMINE

Nos portes, fabriquées avec des matériaux de première qualité, sont offertes dans une vaste gamme de coloris qui leur confèrent l'apparence naturelle des bois les plus nobles.

Consulter nos nuanciers pour connaître notre offre de couleurs.

Made of top-quality materials and offered in a wide variety of colors, our doors emanate a natural beauty usually only to be found with hardwood.

Please consult the Colour Guide to view our colour offer.

- 1 ALLEGRA**
- 2 CONTEMPORAIN**
- 3 DELFINO**
- 4 FASCINATION / LOUISIANA**
- 5 FUSION**
- 6 NEW SHAKER 45° / NEW SHAKER 90°**
- 7 SHAKER 45° / SHAKER 90°**
- 8 TENDANCE 45° / TENDANCE 90°**
- 9 DIMENSIONS MINIMUM DES PANNEAUX MULTIPLES / MINIMUM DIMENSIONS MULTIPLE PANELS**
- 10 MOULURES ET ACCESSOIRES / MOULDINGS AND ACCESSORIES**
- 11 GLACIS / GLAZE**
- 12 GARANTIE / WARRANTY**

POLYESTER

ALLEGRA

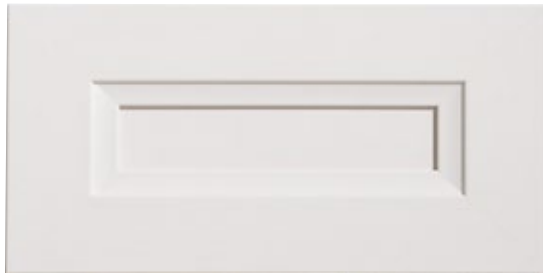

RAINURÉ / GROOVED



SURÉLEVÉ / RAISED



VERRIÈRES / MULLION DOORS

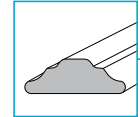
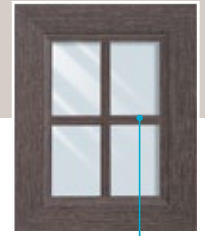

1

PLAT / FLAT

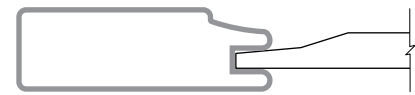
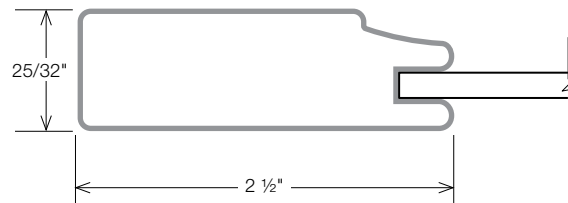

DIMENSIONS MINIMALES / MINIMUM DIMENSIONS

Centre plat et rainuré Flat and Grooved panel	$5 \frac{3}{4} \times 5 \frac{3}{4}$ po/in 146 x 146 mm
Centre surélevé Raised panel	$8 \frac{5}{8} \times 8 \frac{5}{8}$ po/in 219 x 219 mm
Verrière carreaux Multiple mullion	11 x 11 po/in 279 x 279 mm
Mesures pour vitre Sizes for glass	$-4 \frac{5}{16} \times -4 \frac{5}{16}$ po/in -109 x -109 mm

POLYESTER

CONTEMPORAIN

2



RAINURÉ / GROOVED



SURÉLEVÉ / RAISED



VERRIÈRES / MULLION DOORS



PLAT / FLAT

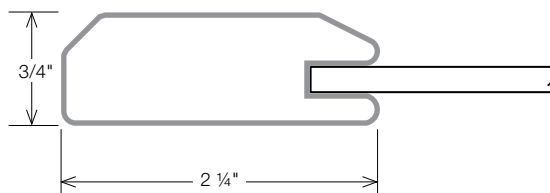

DIMENSIONS MINIMALES / MINIMUM DIMENSIONS

Centre plat et rainuré Flat and Grooved panel	5 1/4 x 5 1/4 po/in 133 x 133 mm
Centre surélevé Raised panel	8 1/8 x 8 1/8 po/in 206 x 206 mm
Mesures pour vitre Sizes for glass	- 3 1/2 x - 3 1/2 po/in - 89 x - 89 mm

DELFINO



RAINURÉ / GROOVED



SURÉLEVÉ / RAISED



VERRIÈRES / MULLION DOORS

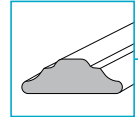
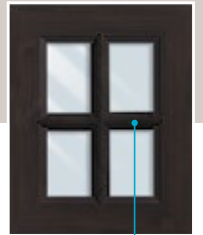
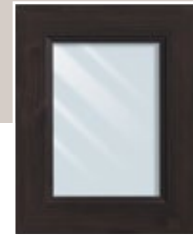

3

PLAT / FLAT

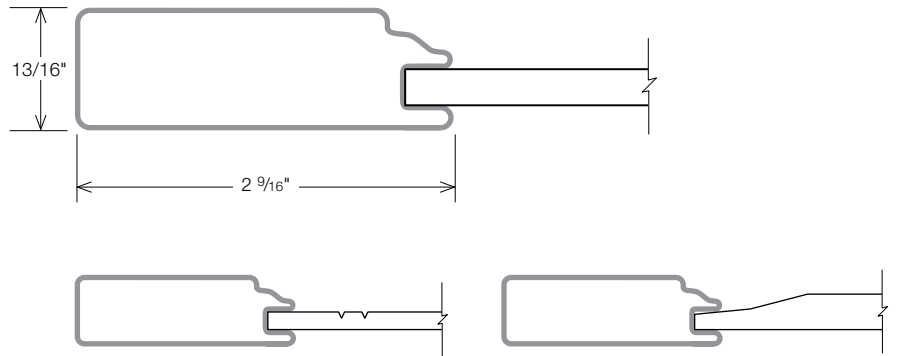

DIMENSIONS MINIMALES / MINIMUM DIMENSIONS

Centre plat et rainuré Flat and Grooved panel	$5 \frac{7}{8} \times 5 \frac{7}{8}$ po/in 150 x 150 mm
Centre surélevé Raised panel	$8 \frac{3}{4} \times 8 \frac{3}{4}$ po/in 223 x 223 mm
Verrière carreaux Multiple mullion	$11 \frac{1}{8} \times 11 \frac{1}{8}$ po/in 283 x 283 mm
Mesures pour vitre Sizes for glass	$-4 \frac{13}{32} \times -4 \frac{13}{32}$ po/in -112 x -112 mm

POLYESTER

FASCINATION / LOUISIANA

4



RAINURÉ / GROOVED



SURÉLEVÉ / RAISED



VERRIÈRES / MULLION DOORS

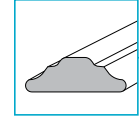
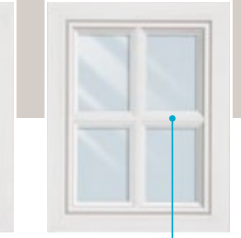

PLAT / FLAT

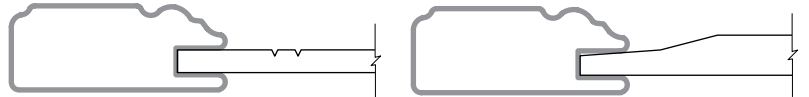
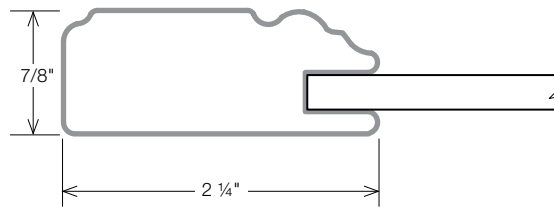

DIMENSIONS MINIMALES / MINIMUM DIMENSIONS

Centre plat et rainuré Flat and Grooved panel	5 1/4 x 5 1/4 po/in 133 x 133 mm
Centre surélevé Raised panel	8 1/8 x 8 1/8 po/in 206 x 206 mm
Verrière carreaux Multiple mullion	10 1/2 x 10 1/2 po/in 267 x 267 mm
Mesures pour vitre Sizes for glass	- 3 1/2 x - 3 1/2 po/in - 89 x - 89 mm

FUSION



RAINURÉ / GROOVED



PLAT / FLAT

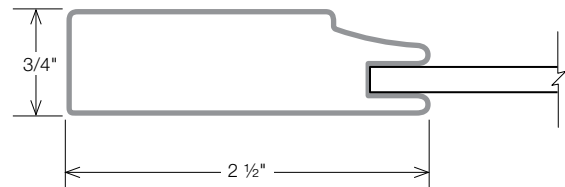
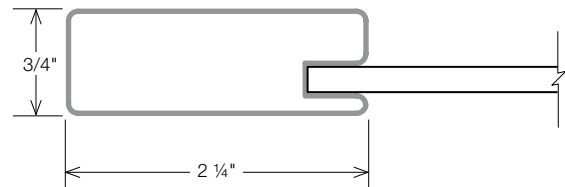

DIMENSIONS MINIMALES / MINIMUM DIMENSIONS

H x L | H x W

Centre plat et rainuré Flat and Grooved panel	5 3/4 x 5 1/4 po/in 146 x 133 mm
Mesures pour vitre Sizes for glass	- 4 5/16 x - 3 3/4 po/in - 109 x - 95 mm

NEW SHAKER 45

6



RAINURÉ / GROOVED



SURÉLEVÉ / RAISED



VERRIÈRES / MULLION DOORS



PLAT / FLAT

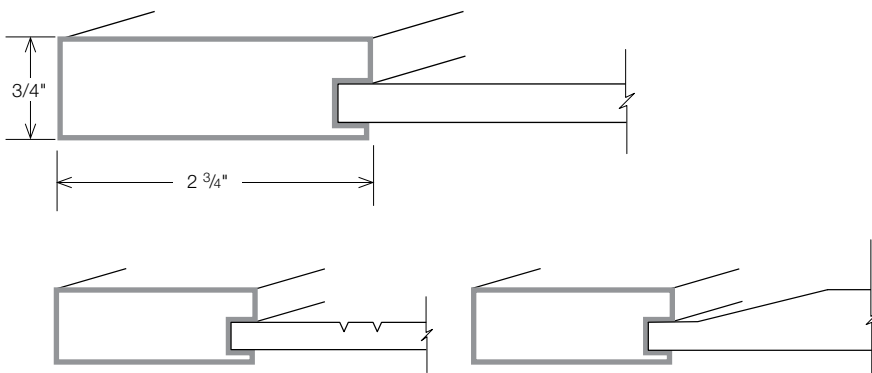

NEW SHAKER 90



DIMENSIONS MINIMALES / MINIMUM DIMENSIONS

	PORTES / DOORS	TIROIRS / DRAWER FRONTS NS 45	TIROIRS / DRAWER FRONTS NS 90
Centre plat et rainuré Flat and Grooved panel	6 1/4 x 6 1/4 po/in 159 x 159 mm	5 x 5 po/in 127 x 127 mm	5 x 6 1/4 po/in 127 x 159 mm
Centre surélevé Raised panel	9 3/8 x 9 3/8 po/in 238 x 238 mm	8 1/4 x 8 1/4 po/in 210 x 210 mm	8 1/4 x 9 3/8 po/in 210 x 238 mm
Verrière carreaux Multiple mullion	8 5/8 x 8 5/8 po/in 143 x 143 mm	X	X
Mesures pour vitre Sizes for glass	-5 1/8 x -5 1/8 po/in -130 x -130 mm	-3 7/8 x -3 7/8 po/in -98 x -98 mm	-3 7/8 x -5 1/8 po/in -98 x -130 mm

NOTE

Battants largeurs réduit 54 mm (2 1/8") pour le New Shaker 90.

Battants réduit 54 mm (2 1/8") pour le New Shaker 45.

Reduced rails 54 mm (2 1/8") for New Shaker 90.

Reduced rails and stiles 54 mm (2 1/8") for New Shaker 45.

SHAKER 45



RAINURÉ / GROOVED



SURÉLEVÉ / RAISED



VERRIÈRES / MULLION DOORS



7

PLAT / FLAT

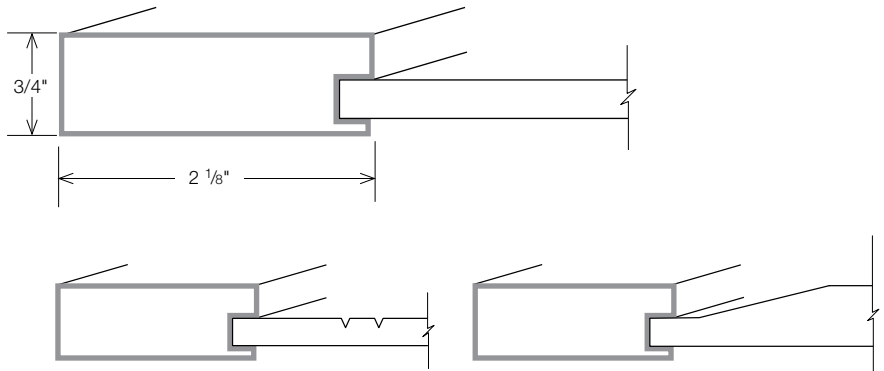

SHAKER 90



DIMENSIONS MINIMALES / MINIMUM DIMENSIONS

Centre plat et rainuré Flat and Grooved panel	5 x 5 po/in 127 x 127 mm
Centre surélevé Raised panel	8 1/4 x 8 1/4 po/in 210 x 210 mm
Verrière carreaux Multiple mullion	8 x 8 po/in 203 x 203 mm
Mesures pour vitre Sizes for glass	- 3 7/8 x - 3 7/8 po/in - 98 x - 98 mm

POLYESTER

TENDANCE 45°

8

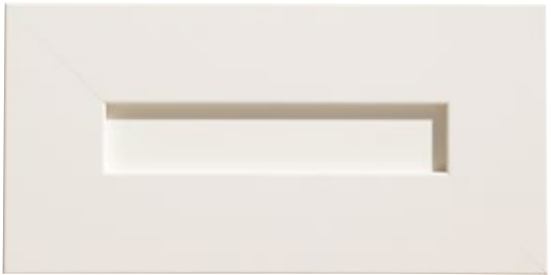

RAINURÉ / GROOVED



SURÉLEVÉ / RAISED



VERRIÈRES / MULLION DOORS



PLAT / FLAT

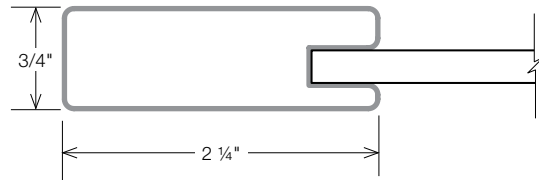

TENDANCE 90°



DIMENSIONS MINIMALES / MINIMUM DIMENSIONS

Centre plat et rainuré Flat and Grooved panel	5 1/4 x 5 1/4 po/in 133 x 133 mm
Centre surélevé Raised panel	8 1/8 x 8 1/8 po/in 206 x 206 mm
Mesures pour vitre Sizes for glass	-3 3/4 x -3 3/4 po/in -95 x -95 mm

PANNEAUX MULTIPLES

DIMENSIONS MINIMUM DES PANNEAUX MULTIPLES MINIMUM DIMENSIONS MULTIPLE PANELS

DOUBLE MOTIF HORIZONTAL / DOUBLE HORIZONTAL PANEL

MODÈLE / MODEL	HAUTEUR / HEIGHT	LARGEUR / WIDTH	MESURE A
Shaker / Toscane	7 ⁷ / ₈ po/in 200 mm	5 po/in 127 mm	3 ⁵ / ₁₆ po/in 100 mm
New Shaker	9 ³ / ₄ po/in 248 mm	6 ¹ / ₄ po/in 159 mm	4 ⁷ / ₈ po/in 124 mm
Tendance	8 ¹ / ₄ po/in 210 mm	6 po/in 152 mm	4 ¹ / ₈ po/in 105 mm

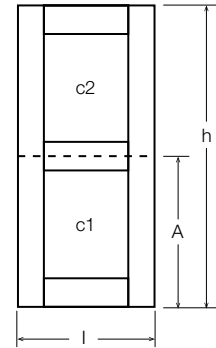

DOUBLE MOTIF VERTICAL / DOUBLE VERTICAL PANEL

MODÈLE / MODEL	HAUTEUR / HEIGHT	LARGEUR / WIDTH	MESURE A
Shaker / Toscane	5 po/in 127 mm	7 ⁷ / ₈ po/in 200 mm	3 ⁵ / ₁₆ po/in 100 mm
New Shaker	6 ¹ / ₄ po/in 159 mm	9 ³ / ₄ po/in 248 mm	4 ⁷ / ₈ po/in 124 mm
Tendance	6 po/in 152 mm	8 ¹ / ₄ po/in 210 mm	4 ¹ / ₈ po/in 105 mm

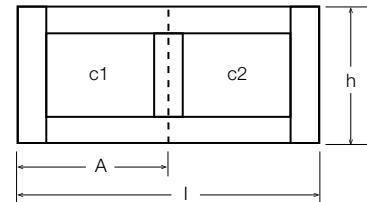

TRIPLE MOTIF HORIZONTAL / TRIPLE HORIZONTAL PANEL

MODÈLE / MODEL	HAUTEUR / HEIGHT	LARGEUR / WIDTH	MESURE A	MESURE B
Shaker / Toscane	10 ³ / ₄ po/in 273 mm	5 po/in 127 mm	3 ⁵ / ₁₆ po/in 100 mm	6 ¹³ / ₁₆ po/in 173 mm
New Shaker	13 ¹ / ₄ po/in 337 mm	6 ¹ / ₄ po/in 159 mm	4 ⁷ / ₈ po/in 124 mm	8 ³ / ₈ po/in 213 mm
Tendance	11 ¹ / ₄ po/in 286 mm	6 po/in 152 mm	4 ¹ / ₈ po/in 105 mm	7 ¹ / ₈ po/in 181 mm

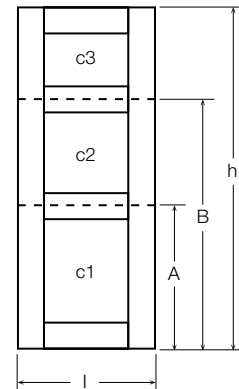

TRIPLE MOTIF VERTICAL / TRIPLE VERTICAL PANEL

MODÈLE / MODEL	HAUTEUR / HEIGHT	LARGEUR / WIDTH	MESURE A	MESURE B
Shaker / Toscane	5 po/in 127 mm	10 ³ / ₄ po/in 273 mm	3 ⁵ / ₁₆ po/in 100 mm	6 ¹³ / ₁₆ po/in 173 mm
New Shaker	6 ¹ / ₄ po/in 159 mm	13 ¹ / ₄ po/in 337 mm	4 ⁷ / ₈ po/in 124 mm	8 ³ / ₈ po/in 213 mm
Tendance	6 po/in 152 mm	11 ¹ / ₄ po/in 286 mm	4 ¹ / ₈ po/in 105 mm	7 ¹ / ₈ po/in 181 mm

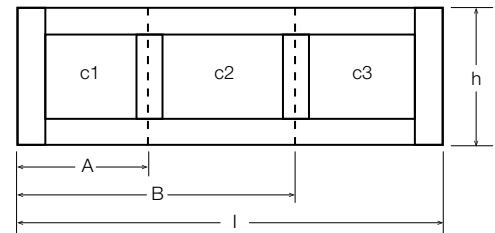

Largeur battant/Rail width Shaker = 2¹/₈ po/in (54 mm)
 Largeur battant/Rail width New Shaker = 2³/₄ po/in (70 mm)
 Largeur battant/Rail width Tendance = 2¹/₄ po/in (57 mm)

MOULURES MOULDINGS

10 MOULURES ET ACCESSOIRES MOULDINGS AND ACCESSORIES

Consulter la charte de moulures accessoires pour les couleurs disponibles et pour plus d'informations, contacter le service à la clientèle.

Consult the accessory moulding chart for colour availability. Please contact Customer Service for more information.

4021
Moulure de tête standard / Standard crown moulding

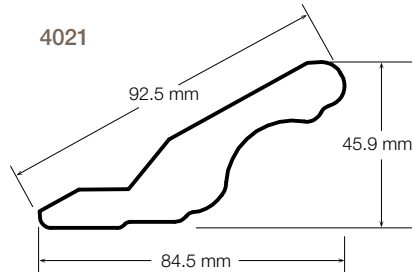

4022
Cache-néon / Light valence

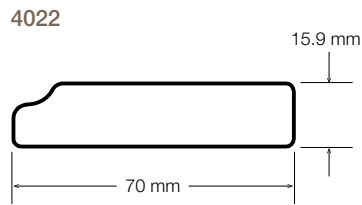

4579
Moulures à carreaux / Mullion moulding

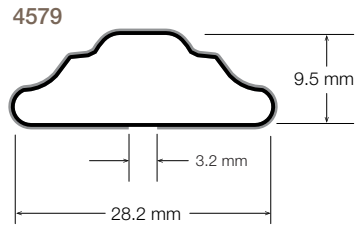

4766
Ogee concave / Concave Ogee

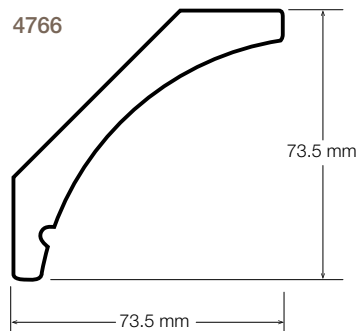

5027
Ogee régulier / Regular Ogee

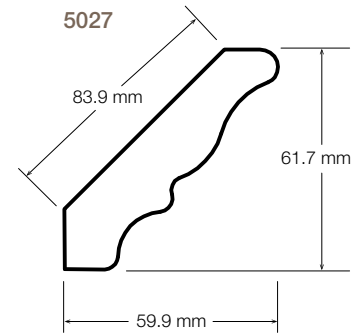

WP22
Moulure de tête contemporaine / Contemporary crown moulding

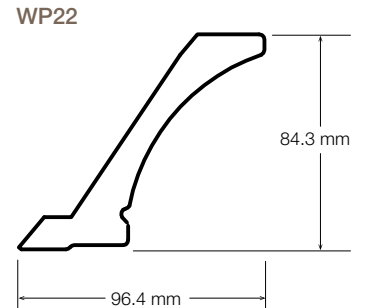

GLACIS GLAZE

OPTION

COULEURS DISPONIBLES / COLORS AVAILABLE

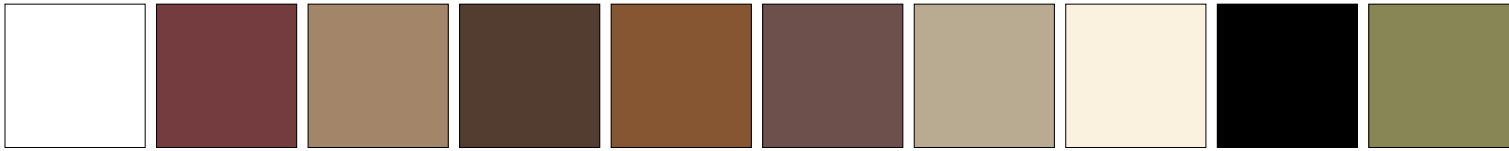

BLANC
WHITE

BORDEAUX
BORDEAUX

BRONZE
BRONZE

BRUN
BROWN

CARAMEL
CARAMEL

CHOCOLAT
CHOCOLATE

GRIS
GREY

IVOIRE
IVORY

NOIR
BLACK

OLIVE
OLIVE

ALLÉGRA
avec glacis / with glaze



DELFINO
avec glacis / with glaze



FASCINATION (LOUISIANA)
avec glacis / with glaze



SHAKER 90 (TOSCANE)
avec glacis / with glaze

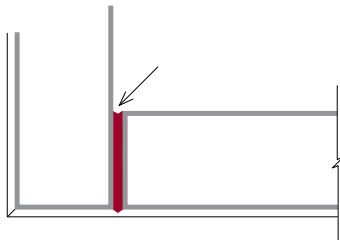

TENDANCE
avec glacis / with glaze



L'application de glacis demeure un procédé artisanale et des variations sont possibles.

The Glaze options are done by hand and variations can and will occur.

- Indique les lignes, ou détails de la porte, où le glacis sera appliqué.
Indicates line details where glaze will remain.



5
ans/years

Garantie Warranty

1. CONDITIONS GÉNÉRALES

CONCEPT AVANTI garantit ses produits distribués et vendus par un distributeur autorisé.

L'installation devrait toujours être effectuée par des professionnels qualifiés. Il est de la responsabilité de la personne installant le produit de déterminer s'il est approprié quant à une application particulière.

CONCEPT AVANTI garantit la qualité du produit contre tout vice apparent ou caché qui affecterait sa qualité ou entraînerait sa détérioration prématurément selon les conditions suivantes :

2. DURÉE

La présente garantie est valable pour une période de 5 ans de la date d'achat.

3. EXCLUSIONS

Cette garantie ne s'applique pas :

3.1 Lorsque les dommages sont causés :

- Par une mauvaise utilisation ou un emploi abusif du produit par l'acheteur;
- Par une installation inadéquate ou à l'extérieur d'une résidence;
- Par une modification, transformation, altération ou correction du produit sans le consentement écrit de CONCEPT AVANTI;
- Par un entreposage inapproprié;
- Par des inconvénients indirects (incluant les dommages incidentaux, spéciaux ou consécutifs);

3.2 À la détérioration du produit résultant d'une usure normale.

3.3 À tous les dommages et inconvénients indirects ou incidents reliés aux coûts d'installation, de transport ou autres, relatives à l'application de la présente garantie.

4. PORTÉE

La présente garantie est non cessible et constitue la seule garantie offerte par CONCEPT AVANTI.

Il n'y a pas de garantie de valeur commerciale ou d'usage particulier, autre que la garantie détaillée ci-haut. CONCEPT AVANTI n'émet aucune autre garantie d'aucune sorte, qu'elle soit explicite ou implicite, orale ou écrite.

5. EXÉCUTION DE LA GARANTIE

Pendant toute la durée de la présente garantie et pour les fins de s'en prévaloir, l'acheteur devra aviser rapidement le distributeur autorisé ou CONCEPT AVANTI de toute défectuosité du produit en lui fournissant une preuve d'achat ou le présent certificat dûment complété au verso. L'acheteur ne pourra faire effectuer aucune réparation avant que le distributeur autorisé n'ait pu être en mesure d'examiner l'état du produit et de son installation.

Lorsque cette garantie est applicable, CONCEPT AVANTI peut réparer les produits en cause, fournir des produits de remplacement ou à sa seule discrétion, offrir le remboursement du prix de vente.

6. DISTRIBUTEUR AUTORISÉ

Seul un distributeur autorisé de CONCEPT AVANTI peut remplir les obligations de garantie contenues aux présentes, selon les termes et conditions des présentes, après avoir obtenu l'autorisation préalable de CONCEPT AVANTI. Le distributeur autorisé n'est pas le mandataire de CONCEPT AVANTI pour lui permettre de modifier ou d'étendre la portée de la présente garantie.

7. SPÉCIFICATIONS TECHNIQUES

Tolérance sur la hauteur et la largeur de +/- 1/32" (0.8 mm);

- Toute porte de moins de 42" de hauteur et 26" de largeur est garantie contre un gauchissement de plus de 1/8"/36".
- Une troisième peinture sera nécessaire pour une porte de plus de 36".

1. GENERAL TERMS AND CONDITIONS

CONCEPT AVANTI guarantees its products which are distributed and sold through an authorized distributor.

The installation should only be done by an experienced professional. It is also the responsibility of the person installing the product to determine its suitability for a particular application.

CONCEPT AVANTI guarantees its products against any apparent or hidden defect that might affect their quality or cause premature deterioration. The following conditions apply:

2. DURATION

The guarantee is valid for a period of 5 years following the date of purchase.

3. EXCLUSIONS

This guarantee does not apply:

3.1 When damages are caused:

- By misuse or abuse of the product by the buyer;
- By improper installation or exposure to the elements;
- By any modification, transformation, or correction of the products without a written authorization from CONCEPT AVANTI;
- By improper storage;
- By any indirect damage (including incidentals, special or consequential damages);

3.2 To any deterioration of the products resulting from normal wear and tear.

3.3 To any damage or incident relating to the costs of installation and transportation, or any other costs relative to the application of this guarantee.

4. SCOPE

This guarantee is unassignable and constitutes the only guarantee offered by CONCEPT AVANTI. There is no guarantee of merchantability or fitness for specific purposes other than the guarantee detailed above. CONCEPT AVANTI makes no other guarantee whatsoever, expressed or implied, oral or written.

5. EXECUTION OF GUARANTEE

For the duration of this guarantee, in order to exercise his rights, the buyer shall notify as soon as possible the authorized distributor or CONCEPT AVANTI of any defect in the product and shall provide proof of purchase or the back of this present certificate properly completed. The buyer shall not make any repairs before the authorized distributor has had an opportunity to examine the product and its installation.

When this guarantee is applicable, CONCEPT AVANTI may repair its products, provide replacement or, at its sole option, offer the reimbursement of the purchase price.

6. AUTHORIZED DISTRIBUTOR

Only an authorized CONCEPT AVANTI distributor may, in compliance with the terms and conditions of this guarantee, assume the obligations contained herein after obtaining prior authorization from CONCEPT AVANTI. The authorized distributor is not mandated by CONCEPT AVANTI to modify or extend the scope of this guarantee.

7. TECHNICAL SPECIFICATIONS

Height & width tolerance of 1/32" (0.8mm).

- Warp tolerance for doors of less than 42" height and 26" width is of 1/8"/36".
- CONCEPT AVANTI recommends the use of a third hinge on doors exceeding a height of 36".



455, avenue Poincaré
Québec (Québec) Canada
G1P 3T7

Téléphone / Telephone
418 627-9797 / 1 877 408-9797

Télécopieur / Fax
418 877-9763

www.premoule.com

Distribué par / Distributed by

En raison du procédé d'impression, les photographies dans ce dépliant peuvent comporter des variations de couleur par rapport à nos couleurs réelles.
Nous vous recommandons de vous procurer un échantillon pour plus d'exactitude.
Photography in this leaflet is for illustration purposes only. Actual quartz color may vary slightly due to the printing process.
For accurate color selection we recommend that you obtain a product sample.

Prémoulé appuie / Prémoulé supports

